

Product datasheet

Specifications



protection relay PowerLogic P1F 24-60V 3CT 1Io: 0.05-12IN 4DI-8DO RS485 USB

REL15012

Main

Range of product	PowerLogic
Product or component type	Protection relay
Relay application	Feeder
product reference	P1
Device mounting	Flush
Mounting support	Fixing kit
Mounting mode	Flush-mounted
power supply	24...60 V AC 24...60 V DC
measuring inputs	: 1/5 A CT phase current 4
number of Digital Inputs (DI)	4
number of Digital Outputs (DO)	8 DO 1 watchdog
type of temperature module connection	1 twisted shielded pair
communication ports	1 RS485 on rear 1 USB type mini B on front
communication protocols	CEI 60870-5-103 Modbus RTU
Cybersecurity	Password protection
protection functions	Breaker failure 50BF Phase overcurrent 50/51 Earth fault overcurrent 50N/51N Lockout relay 86 Thermal overload protection 49 Cold load pick-up Switch ON to fault (SOTF) Inrush detection
Arc flash protection	No
measurement functions	Current 3-phase Current RMS Current peak Current inrush Frequency Temperature overload
control functions	Local/remote control I/O push-button Digital Using serial port
monitoring functions	Circuit breaker monitoring Trip circuit supervision 74 Event counters Relay self-monitoring

logs and records	Event recording Disturbance recording Trip context information
Switchgear diagnosis type	Trip circuit supervision ANSI code: TCS
Connections - terminals	Snap-on fixed Screw clamp terminals fixed

Complementary

Maximum power consumption in W	13.5 W AC 4 W DC
Software name	ESetup Easergy Pro: device setup
Display type	Graphic display terminal
Number of key	9
Local signalling	6 x LED red/orange programmable 1 x LED red relay trip indicator 1 x LED green watchdog
Device connection	Serial port 1 shielded twisted pair
Communication compatibility	IEC 60870-5-103 Modbus RTU
Standards	EN 60255-26:2009 EN 60255-1:2010 EN 60255-27:2005
Product certifications	CE
Height	Embedded: 101.5 mm Total: 116.5 mm
Width	Embedded: 101.5 mm Total: 116.5 mm
Depth	Embedded : 108 mm Total : 119 mm
Net weight	0.8 kg maximum

Environment

Directives	2006/95/EC - low voltage directive 2004/108/EC - electromagnetic compatibility
Electromagnetic compatibility	Electromagnetic immunity level 3 conforming to EN 61000-4-2/3/4/5/6/8
Mechanical robustness	Seismic tests: 2 Gn horizontal, 1 Gn vertical conforming to EN 60255-21-3 Shocks (level: class 1) : 5 Gn for 11 ms conforming to EN 60255-21-2 Shocks withstand (level: class 1) : 10 Gn for 16 ms conforming to EN 60255-21-2 Bumps (level: class 1) : 15 Gn for 11 ms conforming to EN 60255-21-2 Vibrations (level: class 1) : 1 Gn, 10...150 Hz, 1 cycle conforming to EN 60255-21-1
Ambient air temperature for operation	-25...60 °C -30...70 °C (16 h)
Ambient air temperature for storage	-30...70 °C
IP degree of protection	IP54 conforming to IEC 60529
Relative humidity	0...93 % at 40 °C, 21 days 0...93 % at 60 °C, 10 days 93 % at 25...55 °C, 6 cycles, 12 + 12 hours

Packing Units

Unit Type of Package 1	PCE
Number of Units in Package 1	1

Package 1 Height	16.200 cm
Package 1 Width	16.200 cm
Package 1 Length	18.600 cm
Package 1 Weight	1.135 kg
Unit Type of Package 2	S04
Number of Units in Package 2	6
Package 2 Height	30.000 cm
Package 2 Width	40.000 cm
Package 2 Length	60.000 cm
Package 2 Weight	8.058 kg

Contractual warranty

Warranty (in months)	18
-----------------------------	----



Environmental Data

Schneider Electric aims to achieve Net Zero status by 2050 through supply chain partnerships, lower impact materials, and circularity via our ongoing “Use Better, Use Longer, Use Again” campaign to extend product lifetimes and recyclability.

[Environmental Data explained >](#)

[How we assess product sustainability >](#)



Environmental footprint

Total lifecycle Carbon footprint	235 kg CO2 eq.
Carbon footprint of the manufacturing phase [A1 to A3]	76 kg CO2 eq.
Carbon footprint of the distribution phase [A4]	0.3 kg CO2 eq.
Carbon footprint of the installation phase [A5]	0.6 kg CO2 eq.
Carbon footprint of the use phase [B2, B3, B4, B6]	157 kg CO2 eq.
Carbon footprint of the end-of-life phase [C1 to C4]	1 kg CO2 eq.
Environmental Disclosure	Product Environmental Profile

Use Better



Materials and Substances

Packaging made with recycled cardboard	No
Packaging without single use plastic	No
SCIP Number	2140e85d-91da-4f06-9dcd-b67f68a55691
EU RoHS Directive	Compliant By Exemption
REACH Regulation	Reference contains Substances of Very High Concern above the threshold

Use Longer



Lifetime extension

Repair	No
--------	----

Use Again



Repack and remanufacture

Recyclability potential, in %	5
End of life manual availability	End of Life Information
Take-back	No
WEEE Label	 The product must be disposed on European Union markets following specific waste collection and never end up in rubbish bins

Image of product / Alternate images

Alternative



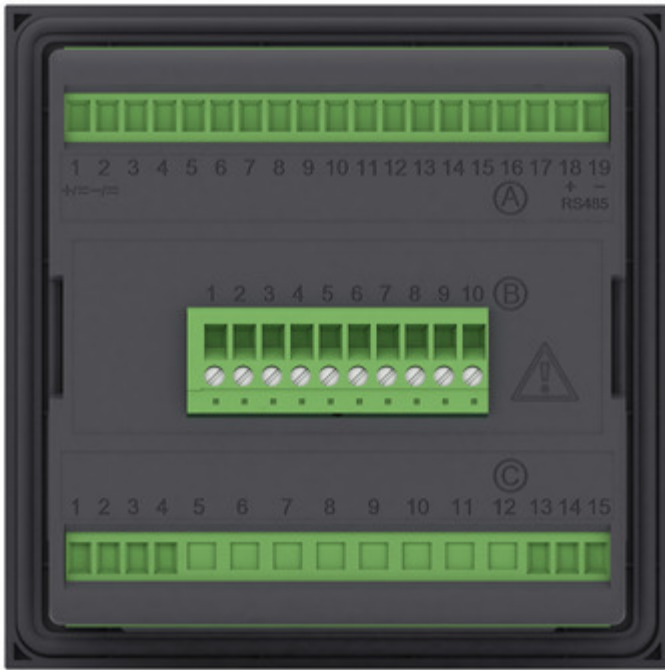

Technical Illustration

Assembly's dimensions

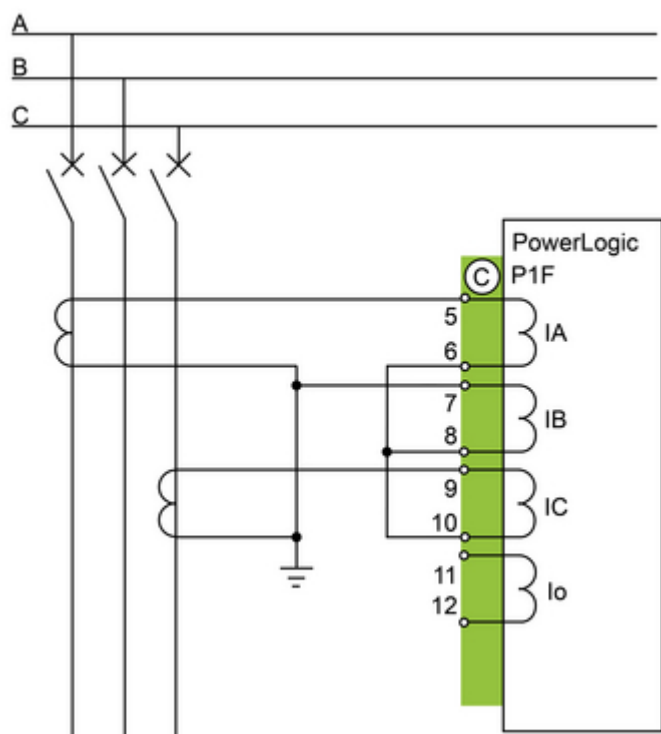

Technical Illustration

Assembly's dimensions

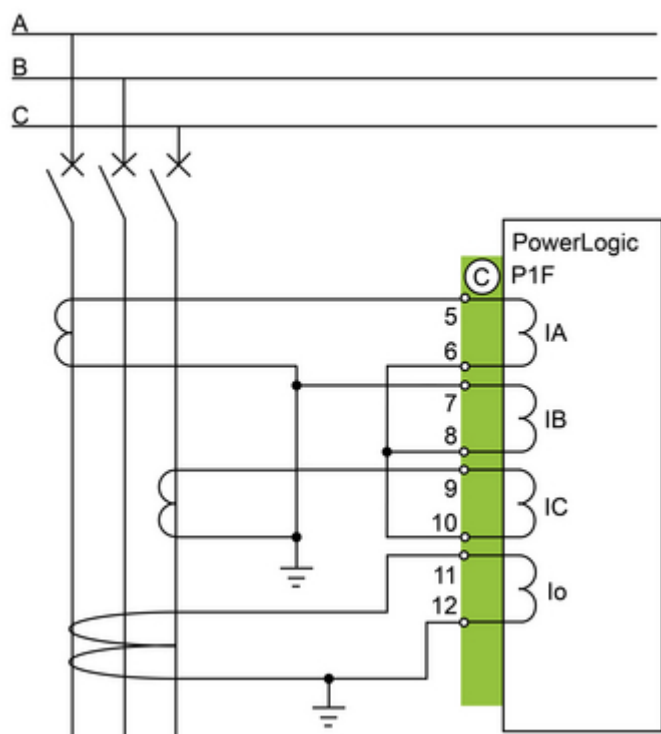

Technical Illustration

Assembly's dimensions

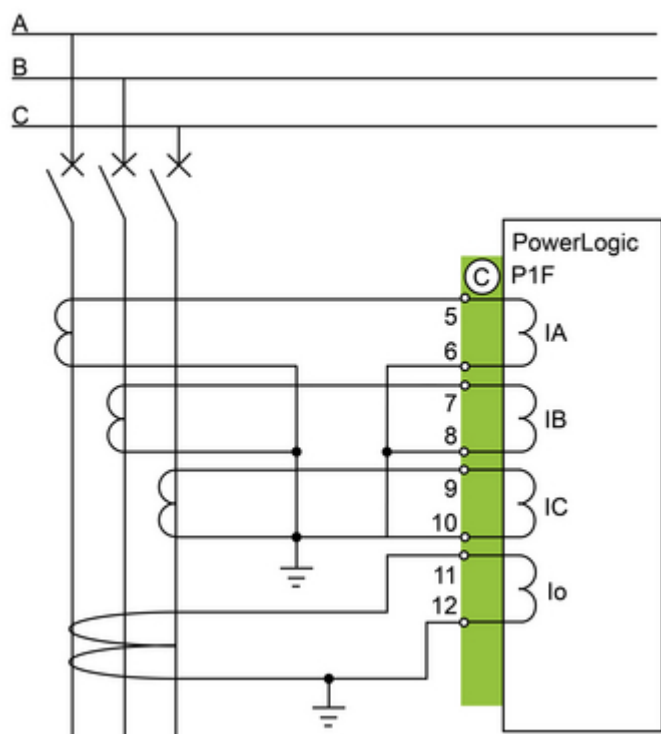

Technical Illustration

Assembly's dimensions

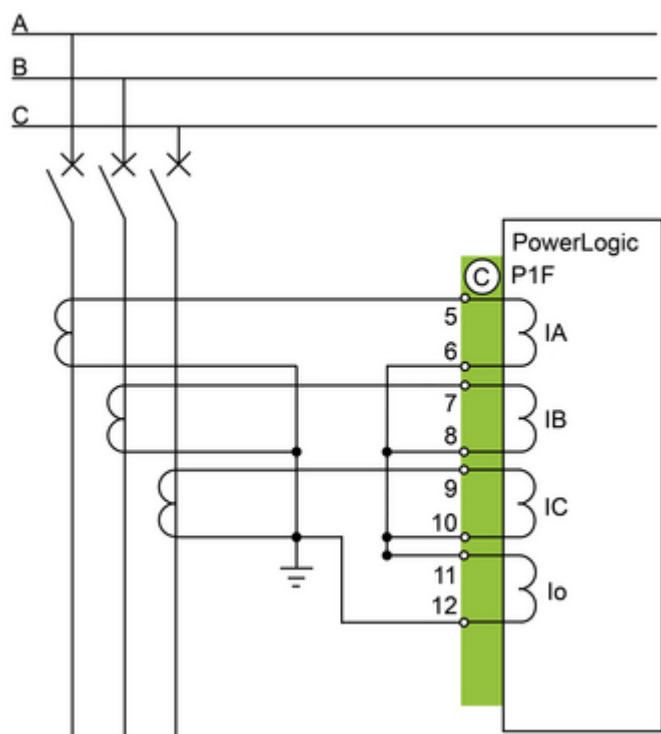

Technical Illustration

Assembly's dimensions

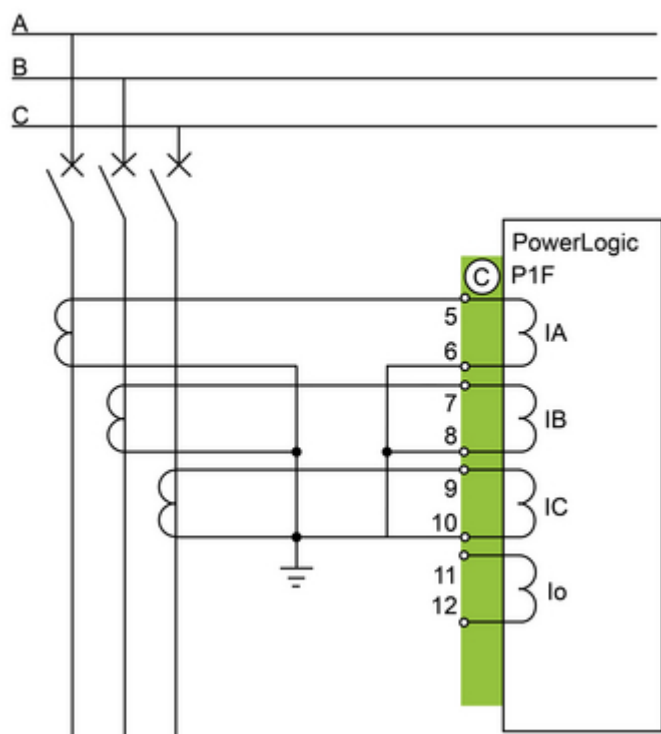

Technical Illustration

Assembly's dimensions

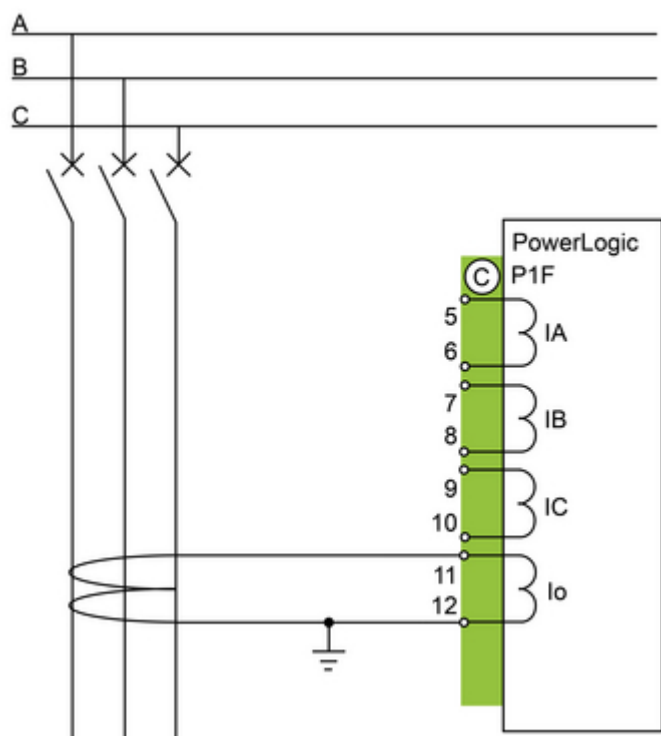

Technical Illustration

Assembly's dimensions

